

12.1-inch Color Radar with Simplified ARPA & 3D View



- Simplified ARPA Function*¹
- DSC Information Display Function*¹
- AIS Overlay Function*¹
- Large 12.1-inch Color TFT Display (600 × 800 dots)
- External Buzzer*² Connection
- Plot Function*¹
- 3D Display Function
- Multi-Lingual User Interface
- Optional Video Output Unit*³
- 4 kW Radome Scanner (MR-1220R4)
- 4 kW Open Array Scanner (MR-1220T4)
- 6 kW Open Array Scanner (4 ft MR-1220T6, 6.5 ft MR-1220T6L)

*¹ External bearing, speed, position, waypoint, variation, AIS and DSC data is (are) required, when you use these functions.

*² User supplied.

*³ UX-234 optional video output unit required.

Advanced Collision Preventing Fun

Collision Risk Management & Safety functions



Simplified Automatic Radar Plotting Aids (ARPA) function^{*1 *2}

The simplified ARPA function assists you to prevent your vessel from colliding with other vessels or objects. When a target enters the preset watch area, it is automatically tracked on the radar echo. By selecting one of the targets, the target information, such as position, course, speed, CPA (Closest Point of Approach), TCPA (Time to CPA), bearing, and distance is displayed. When a target enters the CPA, or it exceeds the set TCPA, an alarm sounds to warn you.

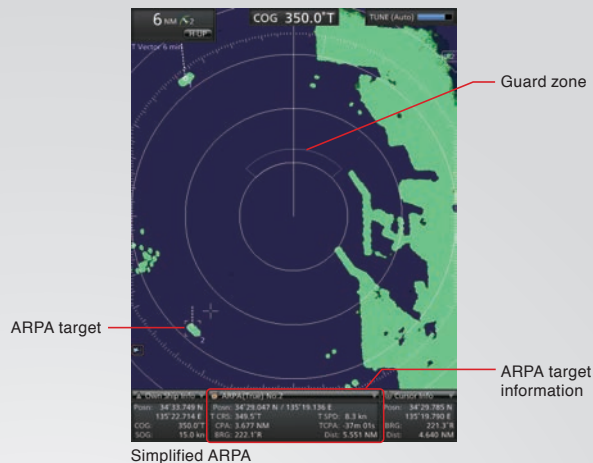

Simplified ARPA



Automatic Identification System (AIS) Overlay function^{*1}

When connected to an external AIS device (including Icom IC-M605 and IC-M506 AIS), up to 100 AIS target icons are overlaid on the radar echo. By selecting an AIS icon, vessel information such as AIS class, MMSI number, vessel name, course, speed, CPA, TCPA, bearing, and distance is displayed.



Compatible Icom marine DSC radio example, IC-M605



AIS Overlay function

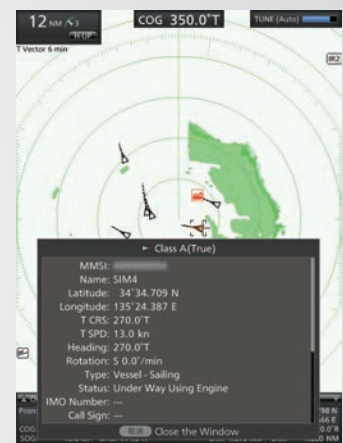

Other vessel AIS information



Digital Selective Calling (DSC) Information Display function^{*1}

When connected to a DSC radio and a DSC call is received, the received message is displayed on the MR-1220. The function shows the DSC message, and the location where the DSC call is transmitted. Up to 20 DSC messages can be plotted. A Man Overboard waypoint can also be displayed.



Received DSC example



External Buzzer Connection^{*3}

The MR-1220 has an external buzzer terminal on the rear panel. You can sound an alarm beeper to effectively inform of danger, when a target enters the TCPA or it exceeds the TCPA.



^{*1} External bearing, speed, position, waypoint, variation, AIS and DSC data is (are) required, when you use these functions.
^{*2} Up to 20 targets are automatically tracked. Additional 10 targets can be tracked when manually set (Automatic Tracking Aid function).
^{*3} User supplied.

Scanner Unit Selections



SC-R40
(2 ft radome scanner)

4 kW Output
36 NM Range



SC-T40
(4 ft open array scanner)

4 kW Output
48 NM Range



SC-T60/SC-T60L
(4 ft / 6.5 ft open array scanners)

6 kW Output
72 NM Range



MARINE RADAR

MR-1220 Series

MR-1220R4
With SC-R40 (4 kW, 2 ft radome scanner)

MR-1220T4
With SC-T40 (4 kW, 4 ft open array scanner)

MR-1220T6
With SC-T60 (6 kW, 4 ft open array scanner)

MR-1220T6L
With SC-T60L (6 kW, 6.5 ft open array scanner)

Plot function



The Plot function records your vessel's longitude and latitude at the set time interval, and displays your track on the radar echo.

Multi-Lingual User Interface



You can select the display language from English, Indonesian, Korean, Malay, Russian, Spanish, Thai, and Vietnamese.

3D Display function



The MR-1220 provides an intuitive bird's-eye view. You can change the display angle according to your own preference. The 2D view can be displayed at the same time.

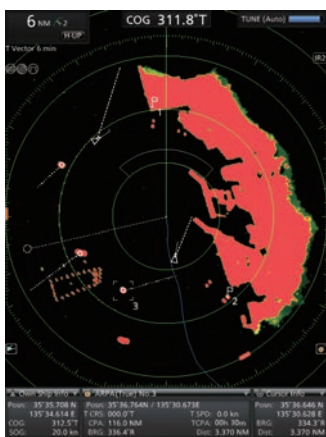

Plot function example

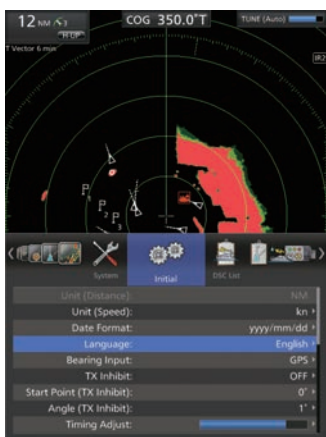

Language setting display

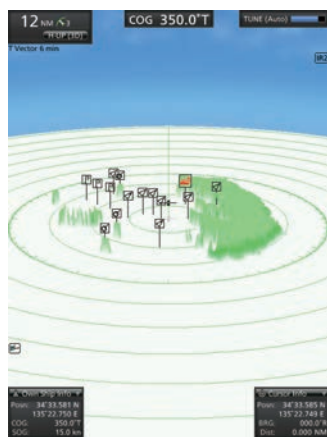

3D display (20°)



3D display (40°) with the 2D view

Other features

- Target Latitude Longitude (TLL) function^{*1}
- True Trail function^{*1}
- Two user programmable alarm zones
- Waypoint indication
- Power Save function
-and more.

SPECIFICATIONS

DISPLAY UNIT	MR-1220			
	MR-1220R4	MR-1220T4	MR-1220T6	MR-1220T6L
Display	12.1-inch color TFT LCD			
Resolution (H x V)	600 x 800 dots			
Minimum range	25 m; 82 ft (at 1/8 NM range)			
Maximum range	36 NM	48 NM	72 NM	72 NM
Power supply requirement	12/24 V DC			
Dimensions (W x H x D; projections not included)	301 x 323.5 x 119.2 mm			
Weight (approx.)	4.8 kg			
Usable temperature range	-15 °C to +55 °C			
Power consumption (approx.)	60 W	70 W	80 W	90 W
Available scanner unit	2 ft (60 cm) radome	4 ft (120 cm) open array	4 ft (120 cm) open array	6.5 ft (200 cm) open array



SCANNER UNIT	SC-R40 (MR-1220R4)	SC-T40 (MR-1220T4)	SC-T60 (MR-1220T6)	SC-T60L (MR-1220T6L)
Type	2 ft (60cm) radome	4 ft (120 cm) open array	4 ft (120 cm) open array	6.5 ft (200 cm) open array
Peak output power	4 kW	4 kW	6 kW	
Rotation speed	24, 36 rpm typical	24, 36 rpm typical	22, 24, 36 rpm typical	
Beamwidth	Horizontal	4° typical	2° typical	2° typical
	Vertical	22° typical	23° typical	23° typical
Sidelobe	-22 dB typical	-24 dB typical	-24 dB typical	-27 dB typical
Transmission frequency	9410 MHz ±30 MHz	9410 MHz ±30 MHz	9410 MHz ±30 MHz	
Dimensions (W x H x D; projections not included)	640 x 256 x 640 mm	1217 (dia.) x 395 (H) mm	1217 (dia.) x 395 (H) mm	1995 (dia.) x 395 (H) mm
Weight (approx.)	8 kg	18 kg	18 kg	20 kg
Usable temperature range	-25 °C to +70 °C	-25 °C to +70 °C	-25 °C to +70 °C	
Connection cable	15 m (OPC-2341)	20 m (OPC-2342)	20 m (OPC-2342)	

All stated specifications are subject to change without notice or obligation.

APPLICABLE IP RATING

Ingress Protection Standard			
DISPLAY UNIT	IPX4	SCANNER UNIT	IPX6

OPTIONS

VIDEO OUTPUT UNIT	SYSTEM CABLES	
 <p>UX-234 Analog RGB output for external monitor</p>	 <p>OPC-2339 20 m (65.6 ft) (Only for SC-R40)</p>	 <p>OPC-2340 30 m (98.4 ft)</p>

Icom, Icom Inc. and the Icom logo are registered trademarks of Icom Incorporated (Japan) in Japan, the United States, the United Kingdom, Germany, France, Spain, Russia, Australia, New Zealand, and/or other countries. This product includes "zlib," "libusb," "freetype," "portmap," "ncurses," and "libjpeg" open source software, and is licensed according to the open source software license. This product is based in part on the work of "Eric Young (eay@cryptsoft.com)," and "Independent JPEG Group."

DIMENSIONS

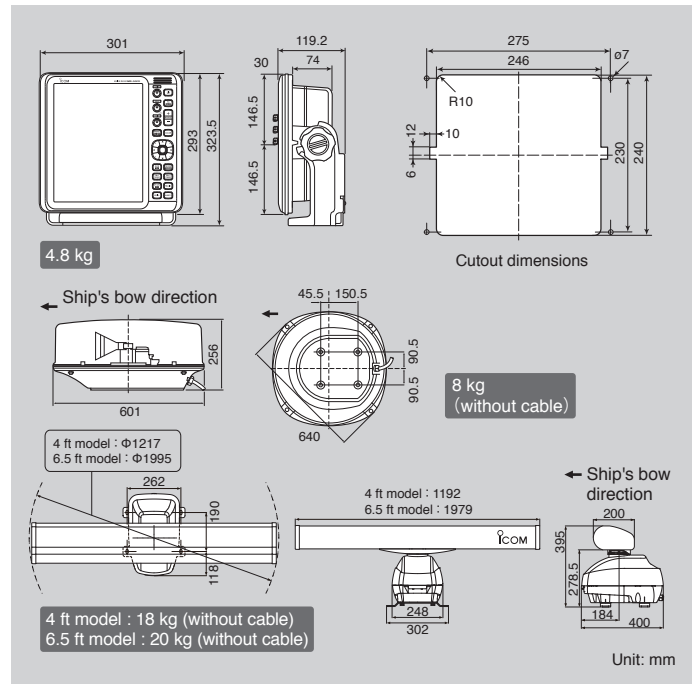

REAR PANEL VIEW

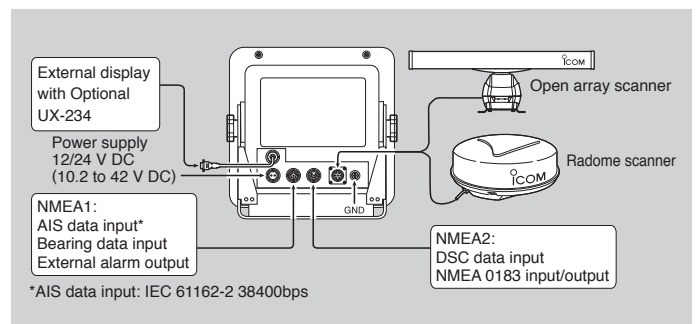

OPTIONAL VIDEO OUTPUT UNIT

With the optional UX-234 video output unit, the MR-1220 can be connected to an external display. The same radar echoes can be displayed on the main and secondary displays at the same time.



Icom Inc. 1-1-32, Kamiminami, Hirano-Ku, Osaka 547-0003, Japan Phone: +81 (06) 6793 5302 Fax: +81 (06) 6793 0013

www.icom.co.jp/world

Count on us!

Icom America Inc.
www.icomamerica.com

Icom (Europe) GmbH
www.icomeurope.com

Icom (Australia) Pty. Ltd.
www.icom.net.au

Your local distributor/dealer:

Icom Canada
www.icomcanada.com

Icom Spain S.L.
www.icomspain.com

Icom (UK) Ltd.
www.icomuk.co.uk

Icom Brazil
E-mail: sales@icombrasil.com

Icom France s.a.s.
www.icom-france.com